

0.35VA SEALED TRANSFORMER EE20 SERIES

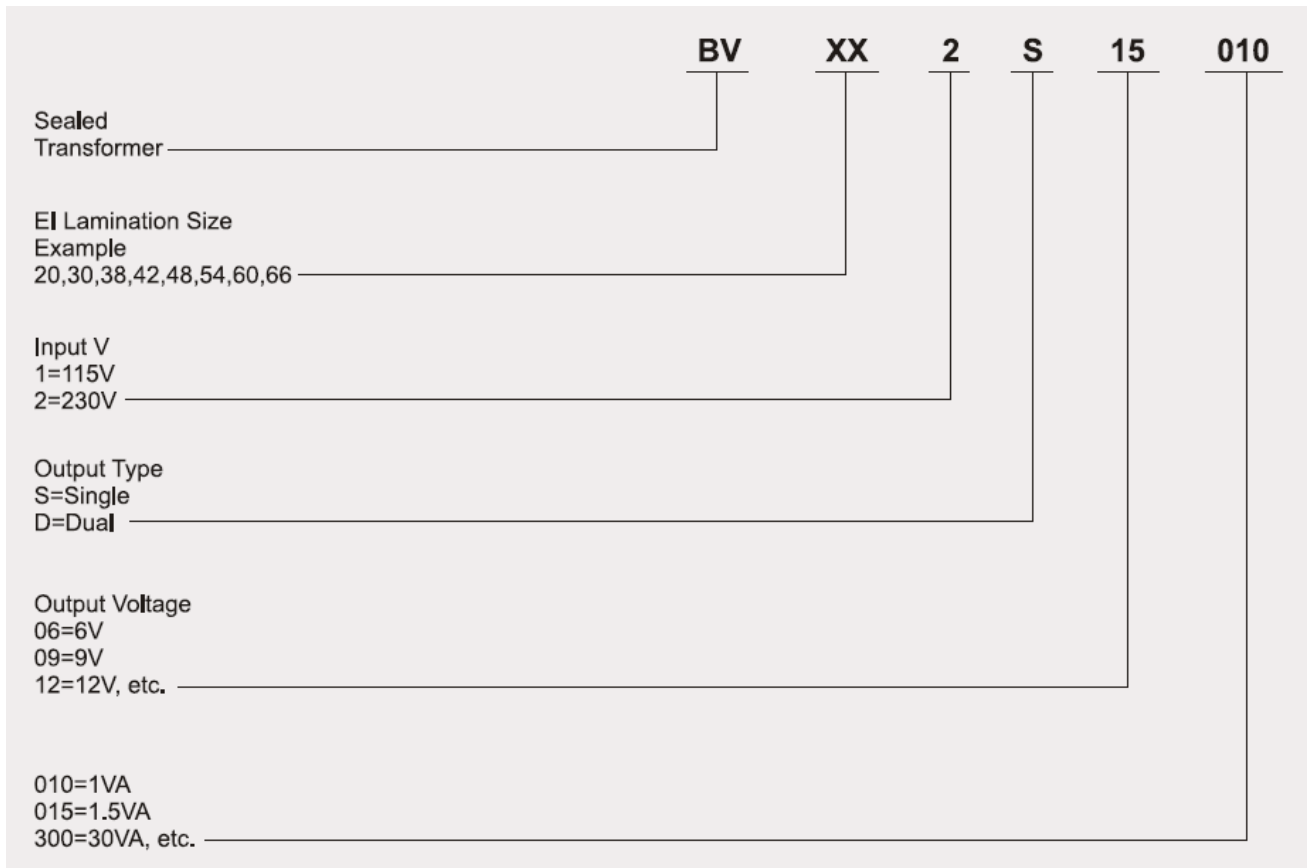

ORDERING CODE



FEATURES

- VDE,UL5085-1,-2,-3,CE Approved:
 UL file No.E214561 class 2/3
 VDE file No.40032785
 CQC file No.: CQC09001030821
- Vacuum Filling
- Split Bobbin Design
- Self-Extinguishing Plastics UL94V-0
- Dielectric Strength 4200Vrms
- Inherently Energy Limited
- Resin Class B IEC 85
 (20,000 h Testing to IEC 216)
- Conforms to EN 61558 and EN 60950
- 100% Production Tested

OUTLINE DIMENSIONS

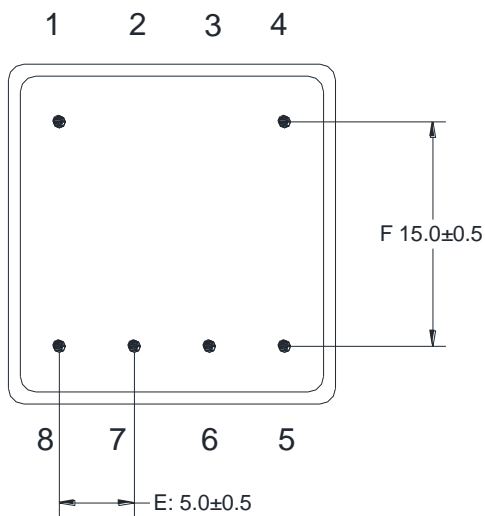
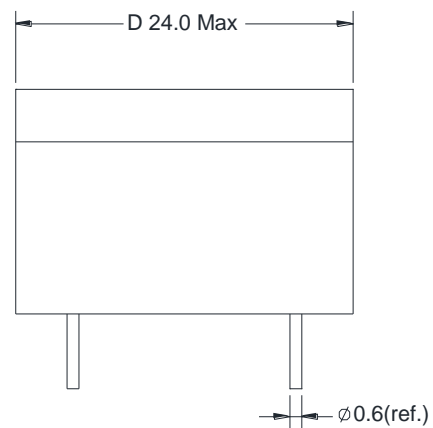
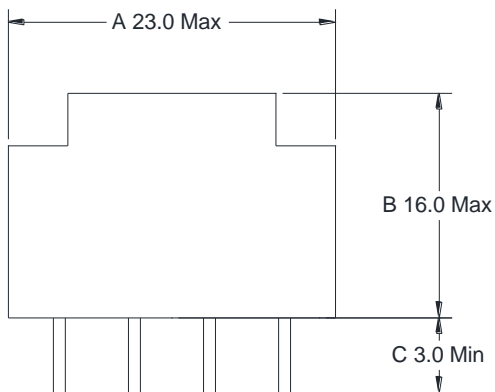

Dual outputs

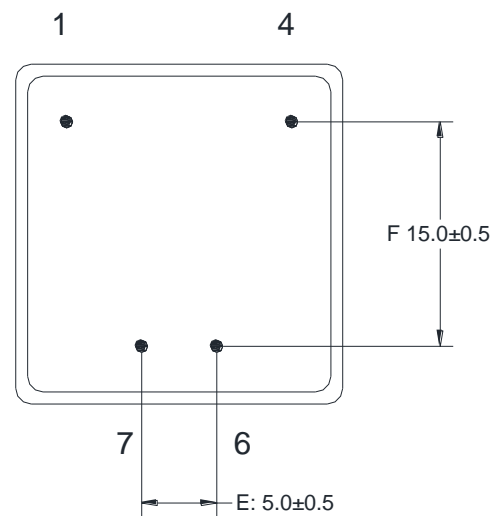

Single output

SCHEMATIC DIAGRAM:

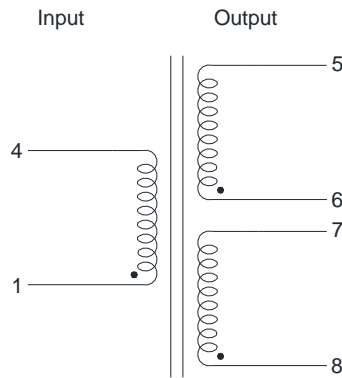

Dual outputs

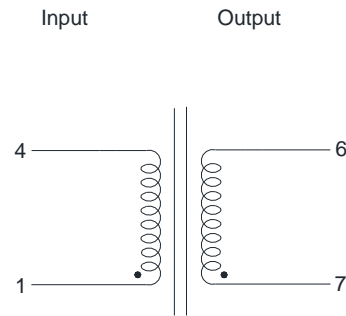

Single output

ELECTRONIC SPECIFICATIONS

Order Number	Input Voltage	SEC.Voltage (Vac)	Rated Power (VA)	No-load Voltage (V)	Ambient TEMP.(°C)	Weight (g)	Certificate			
							VDE	UL	CQC	CE
BV201S06003A	115V 50/60Hz	6	0.35	9.7MAX	T 50 B	29	●	●		●
BV201S09003A	115V 50/60Hz	9	0.35	14.7MAX	T 50 B	29	●	●		●
BV201S10003A	115V 50/60Hz	10	0.35	15.7MAX	T 50 B	29	●	●		●
BV201S12003A	115V 50/60Hz	12	0.35	20MAX	T 50 B	29	●	●		●
BV201S15003A	115V 50/60Hz	15	0.35	26.1MAX	T 50 B	29	●	●		●
BV201S18003A	115V 50/60Hz	18	0.35	31.3MAX	T 50 B	29	●	●		●
BV201S24003A	115V 50/60Hz	24	0.35	40.3MAX	T 50 B	29	●	●		●
BV201D06003A	115V 50/60Hz	2x6	0.35	2x9.7MAX	T 50 B	29	●	●		●
BV201D09003A	115V 50/60Hz	2x9	0.35	2x14.7MAX	T 50 B	29	●	●		●
BV201D10003A	115V 50/60Hz	2x10	0.35	2x15.7MAX	T 50 B	29	●	●		●
BV201D12003A	115V 50/60Hz	2x12	0.35	2x20MAX	T 50 B	29	●	●		●
BV201D15003A	115V 50/60Hz	2x15	0.35	2x26.1MAX	T 50 B	29	●	●		●
BV201D18003A	115V 50/60Hz	2x18	0.35	2x31.3MAX	T 50 B	29		●		●
BV201D24003A	115V 50/60Hz	2x24	0.35	2x40.3MAX	T 50 B	29		●		●
BV202S06003A	230V 50/60Hz	6	0.35	9.7MAX	T 50 B	29	●	●	●	●
BV202S09003A	230V 50/60Hz	9	0.35	14.7MAX	T 50 B	29	●	●	●	●
BV202S10003A	230V 50/60Hz	10	0.35	15.7MAX	T 50 B	29	●	●	●	●
BV202S12003A	230V 50/60Hz	12	0.35	20MAX	T 50 B	29	●	●	●	●
BV202S15003A	230V 50/60Hz	15	0.35	26.1MAX	T 50 B	29	●	●	●	●
BV202S18003A	230V 50/60Hz	18	0.35	31.3MAX	T 50 B	29	●	●	●	●
BV202S24003A	230V 50/60Hz	24	0.35	40.3MAX	T 50 B	29	●	●	●	●
BV202D06003A	230V 50/60Hz	2x6	0.35	2x9.7MAX	T 50 B	29	●	●	●	●
BV202D09003A	230V 50/60Hz	2x9	0.35	2x14.7MAX	T 50 B	29	●	●	●	●
BV202D10003A	230V 50/60Hz	2x10	0.35	2x15.7MAX	T 50B	29	●	●	●	●
BV202D12003A	230V 50/60Hz	2x12	0.35	2x20MAX	T 50 B	29	●	●	●	●
BV202D15003A	230V 50/60Hz	2x15	0.35	2x26.1MAX	T 50 B	29	●	●	●	●
BV202D18003A	230V 50/60Hz	2x18	0.35	2x31.3MAX	T 50 B	29		●		●
BV202D24003A	230V 50/60Hz	2x24	0.35	2x40.3MAX	T 50 B	29		●		●